

Product data sheet Spirotech

Product name

SpiroCombi -DN80 -Flange -HiFlow -Demount

Product properties

A demountable steel (microbubble) deaerator and dirt separator for high flow rate (3 m/s) with a DN50 - DN300 PN16 flange connection

- Combined separation system - removes circulating air and microbubbles effectively
- Applicable for high flow rate systems (3 m/s)
- Applicable with 50/50 Ethylene Glycol / Water (Volume)
- Improve cost control and energy efficiency
- Very small particles, from 5 μm (= 0.005 mm), are separated and removed
- Dirt can be discharged while the system is in operation
- We recommend equipping the separator with shut-off valves on both sides
- In case of severe pollution and/or maintenance, the unit is demountable
- Constant low pressure drop
- PN16 flange connections
- Connection diameters from DN50 - DN300, larger connection diameters on request
- Exceptional guarantee

Article number

HD080F

Product image



Product dimensions

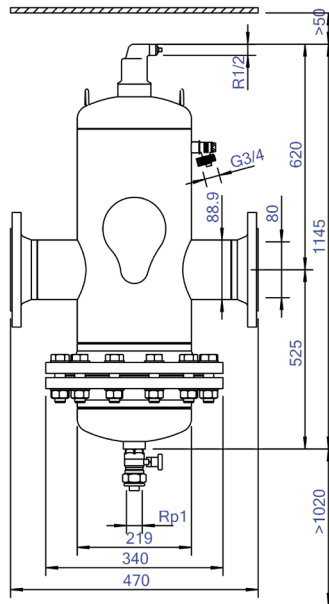

Product data sheet Spirotech

ETIM product data

Housing material	Steel	Construction length	470 mm
With drain tap	Yes	Article compression class	PN 10
Housing material quality	St 37 (1.0254)	Surface protection	Lacquered
Backwash filter	No	Suitable for open system	No
Medium temperature (continuous)	0 - 110 °C	Suitable for closed system	Yes
Max. operating pressure	10 bar	Suitable for solar	No
Kvs value	153.4 m ³ /h	With dismountable filter	Yes
Variable flow direction	Yes	Filter volume	37 l
With insulation	No	Magnet operating principle	No
Separator type	Air/dirt	With automatic de-aerator	Yes
Connection	Flange	Cleaning possible during operation	Yes
Model	Horizontal	With couplers	No
Nominal diameter	DN 80	Inlet/outlet offset distance	0 mm
Max. glycol mixture	50 %	Material of connection	Steel
Suitable for heating	Yes	Flow-through capacity	0 - 54 m ³ /h
Suitable for cooling	Yes	Flange standard	DIN

Disclaimer

This product sheet has been compiled with the greatest possible care. Nevertheless, it may contain errors or omissions. For the most current and correct information we refer you to our website.

