

Product data sheet Spirotech

Product name

EPCK Solo 200L max 4bar

Article number

EPCK-S200-4.0

Product properties

The PicoControl Kompakt SOLO is a compact automatic expansion and pressure-maintaining device. The unit contains 1 pump (1x 100%) and an overflow valve. An unpressurised expansion tank is integrated.

- 1 pump (1x 100%)
- 1 overflow valve (1x 100%)
- Operational pressure range up to 4.0 bar
- 6 possible expansion tank volumes: 45 - 500 liters
- Two further unpressurized expansion tanks can be added
- Maximum expansion volume: 45 – 1,500 liters
- The maximum temperature at the point of connection: 70°C (over 70°C possible with auxiliary tank)
- Maximum safety temperature in the system: 110°C
- Maximum allowable pressure (PN): 6 bar

Product image



Product dimensions

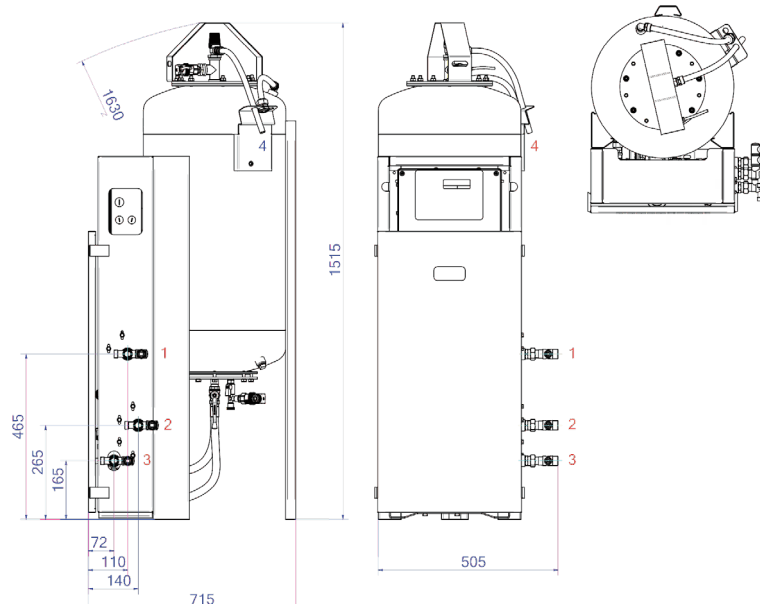

1. Refill connection R3/4
2. Expansion overflow pipe R3/4

3. Expansion pressure pipe R3/4
4. Drain funnel tank safety valve PA 15x12,5 mm

Product data sheet Spirotech

ETIM product data

Height	1515 mm
Volume	200 l
Max. operating pressure	4 bar
Connection	Other
Power consumption	0.22 kW
Couplable	Yes
Electrical connection	Connection cable with plug
Function master/slave	No
With pressure expansion vessel	Yes
Digital control unit	Yes

Double pump/compressor unit	No
With exchangeable membrane	Yes
Compressor in base	No
Nominal diameter expansion connection	3/4 inch (20)
Max. medium temperature (continuous)	70 °C
For heating systems up to	1 MW
Horizontal positioning	No
Connection voltage	230 V
Article compression class	PN 6

Disclaimer

This product sheet has been compiled with the greatest possible care. Nevertheless, it may contain errors or omissions. For the most current and correct information we refer you to our website.

