

Product data sheet Spirotech

Product name

EMCK Solo 75L max 5,6bar

Product properties

The MultiControl Kompakt SOLO is an automatic expansion and pressure-maintaining device, with 1 pump (1x 100%) and an overflow valve. An unpressurised expansion tank is integrated.

- contains 1 pump (1x 100%)
- contains 1 overflow valve (1x 100%)
- Operational pressure range up to 8.1 bar
- Comes with 5 possible vessel volumes: 75, 125, 200, 300 or 500 liters
- Two further vessels can be added.
- Maximum expansion volume: 75 – 1,500 litres
- The maximum temperature at the point of connection: 70°C (over 70°C possible with auxiliary tank)
- Maximum safety temperature in the system: 110°C
- Maximum operating pressure (PN): 10 bar

Article number

EMCK-S75-5.6

Product image



Product dimensions

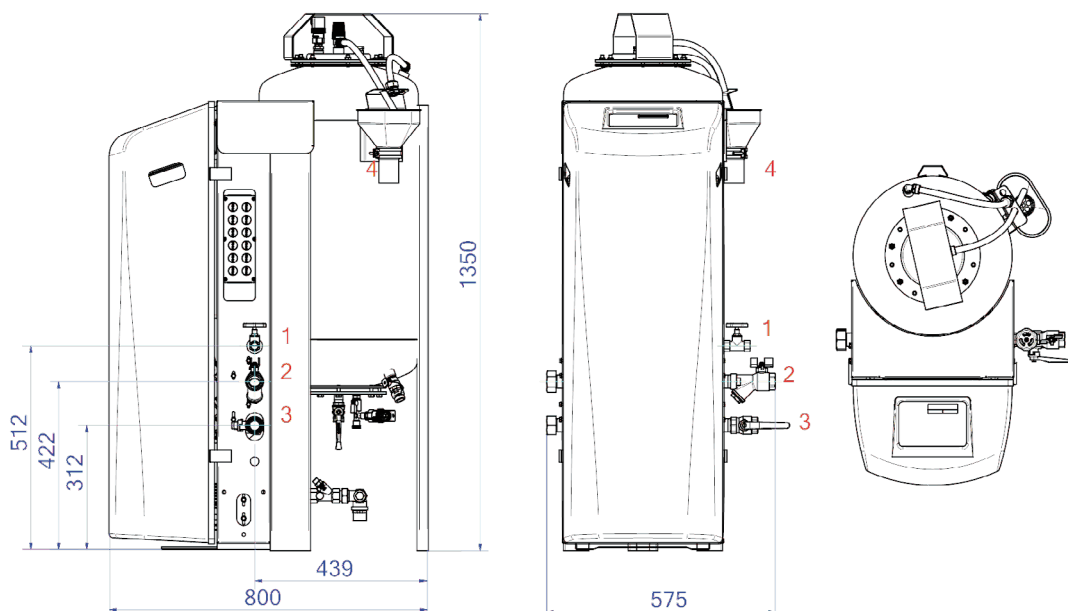

1. Refill connection

Rp1/2

2. Expansion overflow pipe

Rp1

3. Expansion pressure pipe

Rp1

4. Drain funnel tank safety valve

DN50 Geberit

Product data sheet Spirotech

ETIM product data

Height	1375 mm
Volume	75 l
Diameter	406 mm
Max. operating pressure	5.6 bar
Connection	Other
Power consumption	0.6 kW
Couplable	Yes
Electrical connection	Connection cable with plug
Function master/slave	No
With pressure expansion vessel	Yes
Digital control unit	Yes

Double pump/compressor unit	No
With exchangeable membrane	Yes
Compressor in base	No
Nominal diameter expansion connection	1 inch (25)
Max. medium temperature (continuous)	70 °C
For cooling systems up to	4 MW
Outer pipe diameter, expansion connection	33.7 mm
For heating systems up to	0.55 MW
Horizontal positioning	No
Connection voltage	230 V
Article compression class	PN 10

Disclaimer

This product sheet has been compiled with the greatest possible care. Nevertheless, it may contain errors or omissions. For the most current and correct information we refer you to our website.

