

# Product data sheet Spirotech

Product name

**Secondary vessel 300L for EMCK**

Product properties

Additional vessels for EMCK expansion system, only overflow line, without level measurement

Article number

**EMCB-Z300**

Product image



Product dimensions

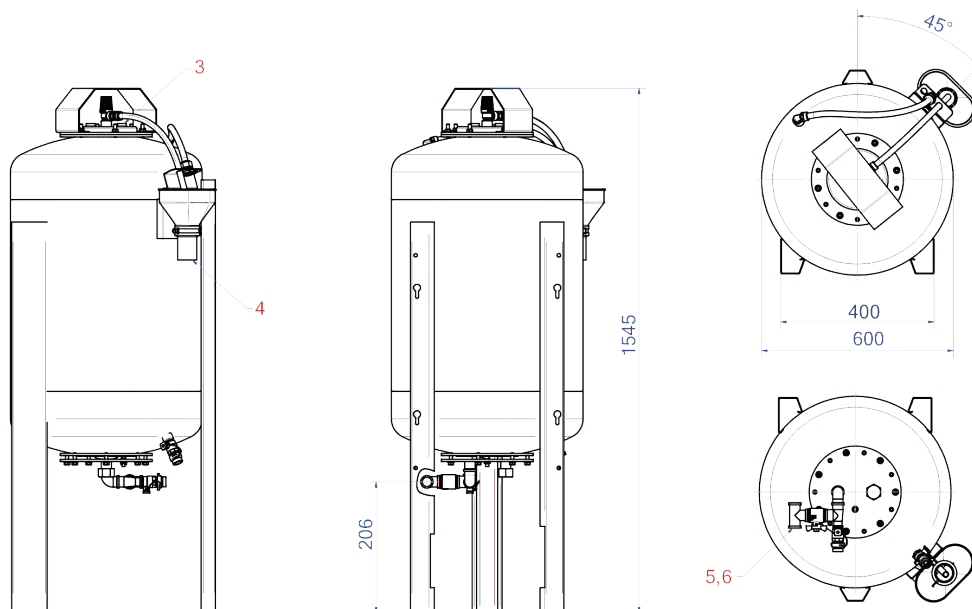

# Product data sheet Spirotech

## ETIM product data

Height	1545 mm
Volume	300 l
Colour	Other
Diameter	600 mm
Medium temperature (continuous)	0 - 70 °C
Max. operating pressure	0.5 bar
With pressure gauge	No
With exchangeable membrane	Yes
Horizontal positioning	No
Suitable for central heating	Yes
Vertical positioning	Yes
With legs	Yes

Material membrane/bladder	Ethylene-propylene diene monomer rubber (EPDM)
Flange compression class	Other
With drain	Yes
Tilting height	1700 mm
With safety valve	Yes
Max. glycol mixture	60 %
Suitable for tap water	No
Max. ethanol mixture	60 %
Suitable for solar collector circuit	Yes
Pre-pressure	0 bar
With fixed wall support	No
Suitable for cooling	No

### Disclaimer

This product sheet has been compiled with the greatest possible care. Nevertheless, it may contain errors or omissions. For the most current and correct information we refer you to our website.

