

Product data sheet Spirotech

Product name

SpiroTrap -DN80 -Flange -Demount

Product properties

A demountable steel dirt separator for standard flow rate (1.5 m/s) with a DN50 - DN300 PN16 flange connection

- Very small particles, from 5 μm (= 0.005 mm) are separated and removed
- Dirt can be drained while the system is in operation
- Applicable with 50/50 Ethylene Glycol / Water (Volume)
- We recommend equipping the separator with shut-off valves on both sides
- In case of severe pollution and/or maintenance, the unit is demountable
- Constant low pressure drop
- Maintenance only takes a few seconds
- No unnecessary downtime
- PN16 flange connections
- Connection diameters from DN50 - DN300, larger connection diameters on request

Article number

BF080F

Product image



Product dimensions

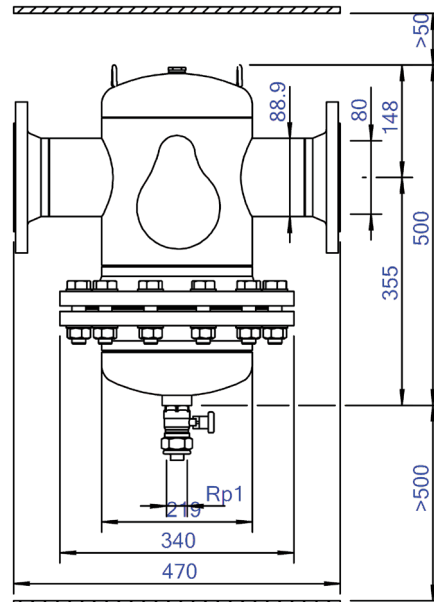

Product data sheet Spirotech

ETIM product data

Housing material	Steel
With drain tap	Yes
Housing material quality	St 37 (1.0254)
Backwash filter	No
Medium temperature (continuous)	0 - 110 °C
Max. operating pressure	10 bar
Kvs value	153.4 m ³ /h
Variable flow direction	Yes
With insulation	No
Separator type	Dirt
Connection	Flange
Model	Horizontal
Nominal diameter	DN 80
Max. glycol mixture	50 %
Suitable for heating	Yes
Suitable for cooling	Yes
Construction length	470 mm
Article compression class	PN 10
Surface protection	Lacquered

Suitable for open system	No
Suitable for closed system	Yes
Suitable for solar	No
Whirl operating principle	No
Negative pressure operating principle	No
With dismountable filter	Yes
Filter volume	17 l
Magnet operating principle	No
Thrust operating principle	No
With automatic de-aerator	No
Partial flow principle	No
Principle full flow with settling	Yes
Cleaning possible during operation	Yes
With couplers	Yes
Inlet/outlet offset distance	0 mm
Material of connection	Steel
Flow-through capacity	0 - 27 m ³ /h
Flange standard	DIN

Disclaimer

This product sheet has been compiled with the greatest possible care. Nevertheless, it may contain errors or omissions. For the most current and correct information we refer you to our website.

