

SPIROTECH SPECIFICATION SHEET



Product: Rp1 1/2" Threaded fitting

Type:

UA150W

Date:

11/19/2019

Customer:

Project:

Reference:

Design criteria

Medium:	Water / glycol (max 50%)	
Max. flow velocity:	1	m/s
Max. flow rate:	5.00	m ³ /h
Max. pressure:	10	bar-g
Max. temperature:	110	°C
Design standard:	EN 13445	

Testing and quality assurance

Leakage test:	no
Test certificate:	no
Design and manufacturing acc. 2014/68/EU:	yes
Material certificates (structural parts):	no
Drawing:	no

Construction materials

Body:	Brass
Deaeration cap:	Brass
Valve sealing:	Viton
Float:	PP
Spirotube Tube:	Copper
Spirotube Wire:	Copper
Spirotube Solder:	Tin(SnCu3)

Drawing

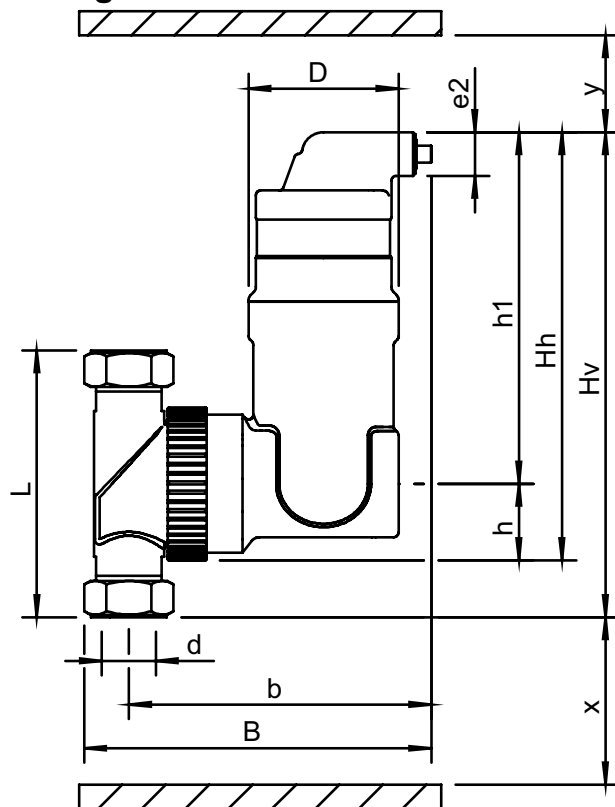

Dimensions

d:	Rp1 1/2"
h:	50 mm
Hh:	276 mm
Hv:	290 mm
h1:	226 mm
L:	128 mm
D:	80 mm
B:	179 mm
b:	152 mm
x:	>50 mm
y:	>50 mm
e2:	R1/2

Volume 1.16 ltr

Dry weight (approx) 4 kg

Subject to changes