

SPIROTECH SPECIFICATION SHEET



Product: SpiroCombi Hi-flow
DN100 Flanged end

Type:
Date:

HC100F
11/19/2019

Customer:

Project:

Reference:

Design criteria

Medium:	Water / glycol (max 50%)	
Max. flow velocity:	3	m/s
Max. flow rate:	94.0	m ³ /h
Max. pressure:	10	bar-g
Max. temperature:	110	°C
Δp at max. flow:	14.8	kPa
Design standard:	EN 13445	

Testing and quality assurance

Test pressure (bar):	7
Test medium:	Air
Test certificate:	no
Design and manufacturing acc. 2014/68/EU:	yes
Material certificates (structural parts):	no
Drawing:	no
Weld procedures:	no
Nondestructive Testing (X-ray: 10%):	no
Notified body inspection:	no

Construction materials

Body:	S235 JR G2 (St.37)
Connections:	S235 JR G2 (St.37)
Fittings:	S235 JR G2 (St.37)
Flanges (EN 1092-1 PN16):	P250GH
Heads:	S235 JR G2 (St.37)
Deaeration cap:	Brass
Valve sealing:	Viton
Float:	PP
Spirotube Tube:	S235 JR G2 (St.37)
Spirotube Wire:	Copper
Spirotube Solder:	Tin(SnCu3)
Paint:	Standard
Color:	Yellow (RAL 1003)
Drain valve:	Nickeled brass

Drawing

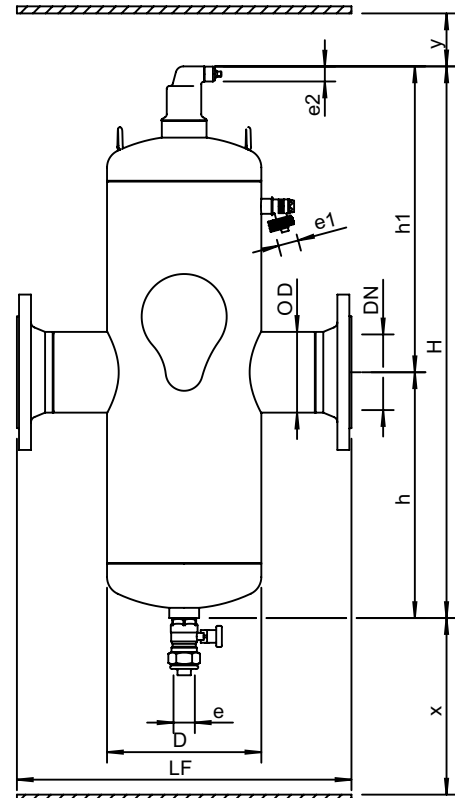

Dimensions

DN:	100
OD:	114.3 mm
H:	1145 mm
h:	525 mm
h1:	620 mm
D:	219 mm
LF:	475 mm
e:	Rp1
e1:	G3/4
e2:	R1/2
x:	>200 mm
y:	>50 mm

Volume:	37 ltr
Dry weight (approx):	45 kg

Subject to changes