

# SPIROTECH SPECIFICATION SHEET



Product: SpiroTrap Demountable  
DN80 Weld end

Type:  
Date:

BF080L  
11/19/2019

Customer:

Project:

Reference:

## Design criteria

Medium:	Water / glycol (max 50%)	
Nom. flow velocity:	1.5	m/s
Nom. flow rate:	27.0	m <sup>3</sup> /h
Max. pressure:	10	bar-g
Max. temperature:	110	°C
Δp at nom. flow:	3.1	kPa
Design standard:	EN 13445	

## Testing and quality assurance

Test pressure (bar):	7
Test medium:	Air
Test certificate:	no
Design and manufacturing acc. 2014/68/EU:	yes
Material certificates (structural parts):	no
Drawing:	no
Weld procedures:	no
Nondestructive Testing (X-ray: 10%):	no
Notified body inspection:	no

## Construction materials

Body:	S235 JR G2 (St.37)
Connections:	S235 JR G2 (St.37)
Fittings:	S235 JR G2 (St.37)
Flanges demountable:	P250GH
Flange packing:	Novapress 815
Heads:	S235 JR G2 (St.37)
Spirotube Tube:	S235 JR G2 (St.37)
Spirotube Wire:	Copper
Spirotube Solder:	Tin(SnCu3)
Paint:	Standard
Color:	Yellow (RAL 1003)
Drain valve:	Nickeled brass

## Drawing

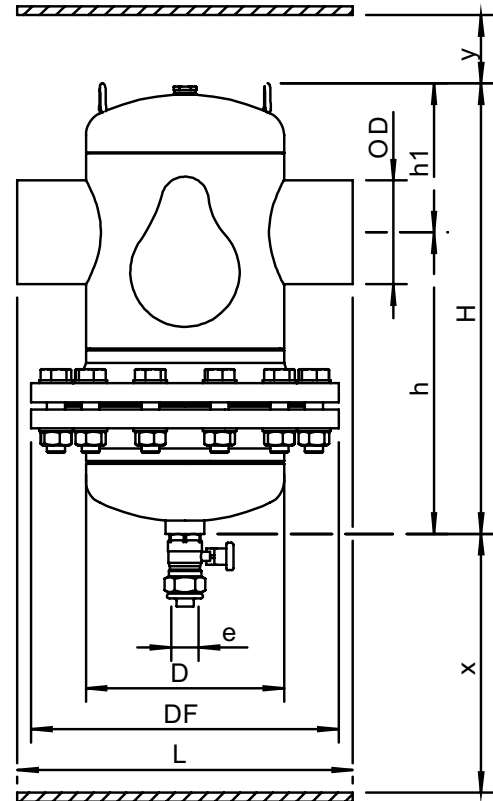

## Dimensions

DN:	80
OD:	88.9 mm
H:	500 mm
h:	355 mm
h1:	148 mm
D:	219 mm
DF:	340 mm
L:	370 mm
e:	Rp1
x:	>500 mm
y:	>50 mm

Volume:	17 ltr
Dry weight (approx):	40 kg

Subject to changes