

SPIROTECH SPECIFICATION SHEET



Product: SpiroTrap Magnet
DN50 Weld end

Type:
Date:

BE050LM
12/21/2020

Customer:

Project:

Reference:

Design criteria

Medium:	Water / glycol (max 50%)	
Nom. flow velocity:	1.5	m/s
Nom. flow rate:	12.5	m ³ /h
Max. pressure:	10	bar-g
Max. temperature:	110	°C
Δp at nom. flow:	2.9	kPa
Design standard:	EN 13445	

Testing and quality assurance

Test pressure (bar):	7
Test medium:	Air
Test certificate:	no
Design and manufacturing acc. 2014/68/EU:	yes
Material certificates (structural parts):	no
Drawing:	no
Weld procedures:	no
Nondestructive Testing (X-ray: 10%):	no
Notified body inspection:	no

Construction materials

Body:	S235 JR G2 (St.37)
Connections:	S235 JR G2 (St.37)
Fittings:	S235 JR G2 (St.37)
Heads:	S235 JR G2 (St.37)
Spirotube Tube:	S235 JR G2 (St.37)
Spirotube Wire:	Copper
Spirotube Solder:	Tin(SnCu3)
Paint:	Standard
Color:	Yellow (RAL 1003)
Dry Pocket:	Copper, Brass
Magnet:	Neodymium
Drain valve:	Nickeled brass

Drawing

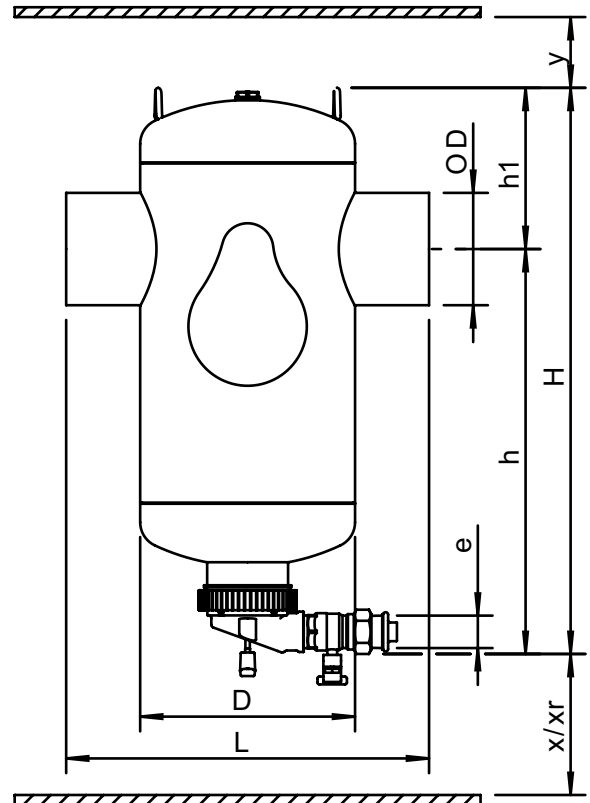

Dimensions

DN:	50
OD:	60.3 mm
H:	471 mm
h:	341 mm
h1:	130 mm
D:	159 mm
L:	260 mm
e:	Rp1
x:	>75 mm
y:	>50 mm
Xr:	>270 mm

Volume:	5 ltr
Dry weight (approx):	8 kg

Subject to changes